

GEBERIT INDUSTRY

GEBERIT SUPPLY AND DRAINAGE SYSTEMS
FOR INDUSTRIAL APPLICATIONS



**KNOW
HOW
INSTALLED**



AUTOMOTIVE



FOOD &
BEVERAGE



PLANT &
MACHINERY



CHEMICAL &
PHARMACEUTICAL



SHIPBUILDING &
OFFSHORE



ENERGY

GEBERIT INDUSTRIAL APPLICATIONS

PROVIDING SOLUTIONS FOR INDUSTRIAL ENVIRONMENTS

Industrial supply and drainage systems for transporting water, oil, gas, compressed air and many other media which fulfills the most demanding safety standards in industrial applications.

With the Know-How and experience gathered over decades, Geberit develops products and systems that guarantee safe, efficient and reliable solutions for a wide range of specialist applications.

CONTENTS

Dedicated Geberit industry team	4
Geberit industry solutions	6
Geberit supply systems	8
Geberit Mapress pressing systems	10
Geberit Mapress seal rings	12
Geberit Mapress for industrial gases	14
Geberit Mapress for natural gases	15
Geberit Mepla	16
Geberit drainage systems	18
Geberit HDPE	20
Geberit connection technology	22
Geberit Mapress connection	24
Industry applications	26
Automotive	28
Food & Beverage	30
Plant & Machinery	32
Chemicals & Pharmaceutical	34
Shipbuilding & Offshore	36
Energy	38
Case studies	40
Approvals	58



DEDICATED GEBERIT INDUSTRY TEAM

SUPPORTIVE, INNOVATIVE AND SOLUTIONS-FOCUSED

The industrywide experience of the Geberit team ensures consistently high standards across every application. Our trusted transporting, sealing, connecting and supplying expertise means that we can also supply you with exceptional service across three key areas:

TECHNICAL EXPERTISE

With our solutions-focused approach, we're always here with the technical advice and support your contractors and engineers need. Our Geberit Industry team are industry experts in the installation, servicing and repairing of Geberit products across a diverse range of sectors, in the most demanding environments.

PRODUCT EXCELLENCE

Geberit products consistently meet the most rigorous safety and performance criteria. Our team has the detailed Know-How to help you choose the perfect solution for every application, together with national and international approvals and expert reports for our products and systems.

UNRIVALLED INSTALLATION SUPPORT

From pre-installation site inspections to step-by-step installation and maintenance guides, we're here to help. We can provide industry-leading training on-site or at our Training Academies and because easy installation is a core benefit of every Geberit product, fitting times are significantly reduced, resulting in considerable cost savings. Once installed, each product also carries the added reassurance of our extended warranty.

WHY GEBERIT?

→ GEBERIT KNOW-HOW

Detailed industrial knowledge. BIM Accreditation. CIBSE approved CPD courses. From technical excellence to transportation expertise, our Know-How is working for our industrial partners worldwide, every day.

→ GEBERIT INNOVATION

With almost 150 years of leading by example, we bring decades of experience and proven innovation to every industrial project.

→ GEBERIT PARTNERSHIP

The Geberit Industry team works closely with engineers and contractors, adding value to every project with industry-leading logistical support, product availability and delivery. To find out more about Geberit industry visit www.geberit.co.uk/industry.

→ GEBERIT RELIABILITY

Our total focus on creating high performing, durable solutions across the industrial, civil, offshore and military shipbuilding sectors, backed by the added reassurance of our extended industry warranty, sets us apart.

→ GEBERIT SUSTAINABILITY

Besides meeting the most demanding safety standards, every Geberit supply and drainage system solution is designed to significantly reduce industry's environmental impact, as part of our long-term contribution to future generations.





INDUSTRIES

A SOLUTION FOR ALL APPLICATIONS

Geberit provide a diverse range of supply and drainage systems that are essential in industry applications - optimising material costs as well as installation time. Significant research into system performance and the quality of materials used means Geberit provide a reliable, cost effective and sustainable range of products for a variety of industrial applications.



AUTOMOTIVE

- Process, cooling and deionised water
- Compressed air
- Oils and fuel
- Technical liquids
- Technical gases



FOOD & BEVERAGE

- Potable water pipes
- Saturated steam
- Detergents and disinfectants
- Technical gases

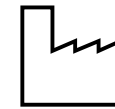

PLANT & MACHINERY

- Process, cooling and deionised water
- Compressed air
- Gases
- Fire extinguishing systems
- Technical liquids



CHEMICAL & PHARMACEUTICAL

- Process, cooling and deionised water
- Compressed air
- Technical gases
- Fire extinguishing systems



SHIPBUILDING & OFFSHORE

- Potable water pipes
- Heating and cooling
- Fire protection systems
- Salt water
- Engine rooms



ENERGY

- Fire extinguishing systems
- Compressed air
- Technical gases
- Fuels

SUPPLY SYSTEMS

VERSATILE, FAST AND RELIABLE FOR INDUSTRY

Today, pressing systems set the standard for reliable supply pipes that are economical to install and maintain. Geberit offer an innovative assortment for industrial applications which are simultaneously tried and tested to meet your requirements.

ECONOMICAL AND RELIABLE PRESSED JOINTS FOR DEMANDING REQUIREMENTS

Geberit is one of the leading European manufacturers offering complete supply solutions for industrial plants.

Geberit pressing systems made of metal or composite materials have demonstrated their worth in many demanding applications and proved their economic efficiency and safety over more than four decades.

- Economical and reliable
- For demanding applications
- Highly developed processing and finishing
- Numerous national and international approvals

HIGH MATERIAL AND PROCESSING QUALITY

Precise weld seams, homogeneous material behaviour and smooth surfaces are key features of Geberit supply and drainage systems for industrial applications. As a result, optimum flow behaviour with perfectly located seals and connections are guaranteed.

APPROVALS AND REPORTS

Numerous national and international approvals and expert reports are available for Geberit products and systems, which are used not only in industry but also on civil and military shipbuilding projects. TÜV reports for high operating pressures and our own reports for a wide range of media provide customers with the reassurance that they are using a tested and safe solution.

The quality management systems from Geberit have been certified by the Swiss Association for Quality and Management Systems SQS according to ISO 9001.



GEBERIT MAPRESS PRESSING SYSTEMS

FOUR MATERIALS FOR ALL KINDS OF INDUSTRIAL REQUIREMENTS

The four materials used for Geberit Mapress pressing systems offer precise and economical solutions for most industrial pipe installations including salt water resistant systems. A wide range of pipe and fitting dimensions paired with application specific seal rings allow for flexible planning and installation.



↑ **GEBERIT MAPRESS STAINLESS STEEL:**
For exacting requirements regarding hygiene and corrosion resistance.

→ For potable water, chemicals and special media. Also available LABS-free and nickel-free



↑ **GEBERIT MAPRESS CARBON STEEL:**
Versatile for economical pipe installations.

→ For heating circuits, fuels and compressed air applications



↑ **GEBERIT MAPRESS COPPER:**
Fittings for industrial process pipe lines.

→ For potable water, chemicals and special media including gases



↑ **GEBERIT MAPRESS CUNIFE:**
For shipbuilding and offshore platforms.

→ Copper/nickel/iron alloy resistant to salt water

GEBERIT MAPRESS STAINLESS STEEL

According to the EN10088-2 standard, the molybdenum content must be at least 2.0%; Geberit Mapress stainless steel system pipes 1.4401 have a molybdenum content of at least 2.2% meaning it's a higher quality stainless steel which is more resistant to corrosion. Geberit Mapress offers extreme corrosion resistance and hygiene. With properties suitable for potable water, industrial gases, coolant, pharmaceutical products and food and beverages.

GEBERIT MAPRESS CUNIFE

The copper/nickel/iron alloy (CuNi10Fe1.6Mn) used in Geberit Mapress CuNiFe is suitable for salt solutions including saturated solutions (approx. 25%). It is certified for civil and military shipbuilding and on drilling platforms for service, pool and heating water, for salt water cooling systems and salt water-operated sprinkler systems.

GEBERIT MAPRESS CARBON STEEL

Geberit Mapress system pipes made of unalloyed steel are the economical solution for closed circuits, cooling water, compressed air or sprinkler systems and fire extinguishing pipes. Geberit Mapress carbon steel pipes and fittings are LABS-free and externally zinc coated. Pipes for sprinkler, compressed air and extinguishing water pipes are manufactured using inside and outside zinc-plated extruded material (sendzimir galvanized).

GEBERIT MAPRESS COPPER

Geberit Mapress copper fittings are used with copper pipes for heating and cooling water systems, solar systems as well as gas or compressed air pipes. CU-DHP, material no. CW 024A is used in compliance with DIN EN 12449. Geberit recommends copper pipes according to DIN EN 1054.



GEBERIT MAPRESS SYSTEMS AT A GLANCE

GEBERIT MAPRESS SYSTEMS	MATERIAL	DIMENSIONS	MAX. OPERATING PRESSURE ¹
Geberit Mapress stainless steel system	1.4401 1.4521	DN 10–100 (d12–d108) DN 10–50 (d12–d54)	75 bar 16 bar
Geberit Mapress carbon steel system	E195, material no. 1.0034 according to DIN EN 10305, outside zinc-plated; E220, material number 1.0215 according to DIN EN 10305, inside and outside sendzimir galvanized	DN 10–100 (d12–d108) DN 20–100 (d22–d108)	40 bar 40 bar
Geberit Mapress copper system	Recommendation for copper pipes according to CU-DHP, material no. CW024A	DN 10–100 (d12–d108)	40 bar
Geberit Mapress CuNiFe system	CuNi10Fe1.6Mn	DN 12–100 (d15–d108)	13 bar

¹Depending on the pipe dimension and type of pressing operation according to TÜV component identification TÜV.A. 271-12
²Any pressure above 16 bar should be confirmed by request and is size dependent.

GEBERIT MAPRESS SEAL RINGS

THE RIGHT SEAL FOR THE RIGHT APPLICATION

The seal ring plays an important role in the safety of industrial pipe installations. Geberit Mapress provides special seal rings for various media which cover practically all applications in industry and shipbuilding.



- Geberit pressing technology for reliable, leakproof connections
- Four different seal rings for most applications
- Clear colour differentiation of the application ranges
- With CIIR black, visibly leaks if unpressed, for high processing safety
- A large number of national and international approvals



SYSTEM COMPONENTS WITH PERFECT INTERPLAY

The Geberit Mapress pressing system consists of the system pipe, fitting and seal ring; these components are perfectly adapted to one another. The press connection ensures mechanical strength, while special O-rings ensure tightness. The media that can be transported in Geberit Mapress supply systems depend on the material and the selected seal ring.

O-RINGS FOR PERMANENT TIGHTNESS

In many standard or special applications in industry, fittings and pipes have to fulfil special requirements or standards. The media that are allowed to be transported depend directly on the seal ring that is used.

GEBERIT MAPRESS SEAL RINGS: ADAPTABLE FOR MANY APPLICATIONS

With its material properties that render it resistant to temperatures and chemicals, the Geberit Mapress seal ring FKM blue can be used for a wide range of solar and industrial applications. It is resistant to temperatures from -20°C up to 220°C, and is suitable for solar media, mineral oil, heating oil, air containing oil as well as many other industrial media.

All press fittings for applications in "solar systems" and "industry" are fitted with the new blue seal ring at the factory. The Geberit Mapress seal ring FKM white is available specifically for saturated steam applications. The Geberit Mapress seal ring HNBR yellow is suitable for gas installations, the Geberit Mapress FKM blue for oil applications. The Geberit Mapress seal ring CIIR black is used in potable water installations and various industrial applications.

GEBERIT MAPRESS SEAL RINGS (O-RINGS) FOR SPECIAL APPLICATIONS

APPLICATIONS	SEAL RING	GEBERIT MAPRESS Copper	GEBERIT MAPRESS Carbon Steel	GEBERIT MAPRESS Stainless Steel	GEBERIT MAPRESS CuNiFe	GEBERIT MAPRESS GAS Copper and Stainless Steel
Potable water						
Heating						
Cooling and refrigeration						
Gas						
Offshore						
Industry						
Fixed fire extinguishing systems						
Solar systems						
Ship building						
Saturated steam						

GEBERIT MAPRESS INDUSTRIAL GAS

Geberit Mapress stainless steel gas and Geberit Mapress copper gas pressing systems offers a high quality and economical alternative to welded, soldered or screwed piping systems for gas applications. The positive-fit and lengthways non-positive connections are quick and easy to assemble and guarantee a high degree of tightness (leak rate 1×10^{-5} mbar l/s).

GEBERIT MAPRESS STAINLESS STEEL / STAINLESS STEEL GAS

System pipes and press fittings made of high-alloy, austenitic, stainless CrNiMo steel with material number 1.4401 in accordance with BS EN 10088, with dimensions d12-108 with TÜV component ID TÜV.A.271-07.

NOTE

Geberit's manufacturing standard defines and guarantees the highest quality standards. All system pipes and fittings are metallically bright, free of grease and oil, hygienically perfect and free of corrosive materials when delivered. The operating pressures listed in the TÜV component certificate are significantly limited by test reports, expert reports, standards and/or regulations in some cases depending on the medium (gas or combustible liquids, for example). Details available on request.



GEBERIT MAPRESS FOR INDUSTRIAL GASES

Gas type	PIPES/FITTINGS					SEAL RINGS			Temperature range (°C)	Remarks
	Stainless steel 1.4401	Stainless steel, Silicone free 1.4401	Stainless steel gas 1.4401	Copper ¹ CW 024 A	Copper gas ¹ CW 024 A	Seal ring CIIR Black	Seal ring HNBR Yellow	Seal ring FKM Blue		
Acetylene	✓	✓				✓			-10 to +50	
Argon	✓	✓		✓		✓			-10 to +60	
Natural gas			✓		✓		✓		-20 to +70	
Carbon dioxide	✓	✓				✓			-10 to +60	
Methane			✓		✓		✓		-20 to +70	
Propane			✓		✓		✓		-20 to +70	
Oxygen		✓				✓			-10 to +60	
Nitrogen	✓	✓		✓					-10 to +60	
Hydrogen	✓	✓							-10 to +60	
Shielding gases	✓	✓		✓					-10 to +60	
Compressed air	✓	✓		✓				✓	-20 to +100	DL class 4, ISO 8573 and upwards: Seal ring FKM, blue
Synthetic air	✓	✓		✓					-20 to +100	

¹ In connection with quality copper pipes in accordance with BS EN 1057. Further gases and max. permissible operating pressures depending on gas type on request

GEBERIT MAPRESS NATURAL GAS

GEBERIT MAPRESS STAINLESS STEEL GAS

- BS316 S33 pipe and fittings
- 15-108mm



GEBERIT MAPRESS COPPER GAS

- Fittings only
- 15-54mm



APPROVED FOR USE WITH:

- Natural Gas
- For above ground use only

APPROVALS INCLUDE:

- BSI
- DVGW VP 614
- OVGW G1 TR Gas (A)
- BS 1775
- BS 6891

GEBERIT MAPRESS SEAL RING HNBR YELLOW

MATERIAL	MIN OPERATING TEMP	MAX OPERATING TEMP	MAX OPERATING PRESSURE
Hydrogenated acrylonitrile-Butadiene rubber	-30°C	70°C	5 bar

Please note: For Geberit Mapress Copper Gas & Stainless Steel Gas Fittings only

FIRE ENDURANCE TEST NO. 120005083 12/09/2017

Test of resistance to high temperature (HTB) on stainless steel press fittings "Mapress Stainless Steel gas" in dimensions 22mm, 54mm and 108mm following Technical Standard DVGW G 5614(P): 2013-12, clause 4.10, in connection with system pipes "Mapress Stainless" (1.4401) as per DVGW worksheet GW 541: 2004-10, table 3.

By way of derogation from the requirements stated in Technical Standard DVGW G 5614(P): 2013-12, clause 4.10, the test temperature was 800°C instead of 650°C.

The stainless steel press fittings "Mapress Stainless Steel Gas" in dimensions 22mm, 54mm and 108mm were subjected to the following test, which was performed on calibrated test stand following Technical Standard DVGW G 5614(P): 2013-12 corresponding to the listed clause.

One sample of dimension 22mm, 54mm and 108mm each was subjected to HTB-test following Technical Standard DVGW G 5614(P): 2013-12, clause 4.10. The samples were inserted into a preheated tube furnace and after reaching the test temperature the samples were applied with the testing pressure. The leakage measurements were determined with a mass flow meter.

TEST TEMPERATURE

800°C

TEST PRESSURE (GT)

5 bar

TEST DURATION

30 mins

TEST MEDIUM

Nitrogen

MEASURING EQUIPMENT

Manometer K 5281, Mass Flow Meter K 5278, Memory Thermometer K 5390

The maximum permissible leakage rate of 30 dm³/h per pressing joint (60 dm³/h per sample) shall not be exceeded.



GEBERIT MEPLA MULTILAYER PIPE

FOR FLEXIBILITY AND HIGH PERFORMANCE

Easy, reliable processing and a comprehensive range of pipe dimensions and fittings make Geberit Mepla a flexible, economical piping system. This means Geberit Mepla is suitable for a variety of applications for industrial situations like potable water. Geberit Mepla complies with the required hygiene and safety standards.

VERSATILE AND ECONOMICAL IN INDUSTRY

The Geberit Mepla pressing system is used in the automotive, chemical, pharmaceutical and food and beverage industries for compressed air systems, vacuum systems, cooling systems, process and potable water pipes as well as heating. Geberit Mepla permits easy, reliable and flexible processing. It complies with high hygiene standards and is both reliable and permanently leakproof in operation.

THREE LAYERS FOR RELIABLE APPLICATION WITH WATERS AND COMPRESSED AIR

Geberit Mepla system pipes combine the quality advantages of both plastic and metal. The stabilising core comprising an aluminium pipe is surrounded on the outside by a protective coating of PE, which provides protection against corrosion and mechanical loads. The central, longitudinally butt-welded aluminium layer makes the pipe stable, bendable and forms a barrier against diffusion. The inner layer of PE-RT is corrosion-resistant and food-safe.

CONNECTIONS WITH TRIPLE RELIABILITY

Geberit Mepla offers triple safety. The insertion depth is visible and indicates the correct position of the fitting on the pipe. A tool guide rim ensures that the pressing tool is correctly positioned. Defined leak paths also ensure that fittings which have not yet been pressed can be clearly detected during the leak test.

- Combines the advantages of plastic and metal
- Corrosion-resistant and food-safe
- Extensive assortment with 8 pipe dimensions and 300 fittings
- Simple processing
- Fire protection can be achieved simply and cost-effectively

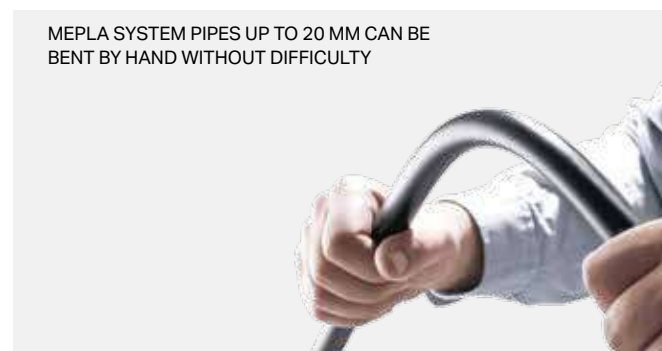

→ Reliably sealed, Geberit Mepla pipes stay hygienically clean until they are installed.



← Geberit Mepla fittings: perfect drinking water hygiene due to the plugs employed.



MAXIMUM PERMITTED TEMPERATURE AND PRESSURES

APPLICATION / UNIT	OPERATING TEMPERATURE °C	OPERATING PRESSURE MPA (BAR)
Potable water	0-70	1.0 (10)
Heating water ⁽¹⁾	0-80	1.0 (10)
Cooling water without antifreeze agent ⁽¹⁾	0-70	1.0 (10)
Cooling water with antifreeze agent ⁽²⁾	0-40	1.0 (10)
Treated water ⁽³⁾	0-70	1.0 (10)
Grey/rainwater	0-40	1.0 (10)
Sea water	0-70	1.0 (10)
Compressed air ⁽⁴⁾	0-40	1.0 (10)
Vacuum (negative pressure)	0-40	≥ 0.02 (0.2)

(1) Closed circuit

(2) Only use approved corrosion-protection agents

(3) Gunmetal fittings are not suitable for ion-free water.

(4) Purity class oil 0-3 according to ISO 8573-1:2010E.

GEBERIT DRAINAGE SYSTEMS

FOR A SAFE, EFFICIENT AND RELIABLE SOLUTION

GEBERIT HDPE WITHSTANDS TEMPERATURES, PRESSURE AND CHEMICALS

Significant temperature changes, aggressive waste waters, pressure, shifts and chemical influences: Geberit HDPE effortlessly withstands the loads in industrial and laboratory disposal or the loads on buried parts.

The robust and shockproof piping material of high density polyethylene (HDPE) is resistant to abrasion, not affected by acids, lyes or other aggressive waste waters. It is also resistant to heat and cold (hot water up to 80 °C, short-term up to 100 °C without simultaneous mechanical load, cold water down to -40 °C).

- Geberit HDPE: flexible, shockproof, resistant to heat, cold and chemicals
- Large range of products and wide range of dimensions
- Flexible and impact resistant
- Various jointing options
- Environmentally friendly plastic
- Fire protection: Geberit fire protection sleeves RS90 Plus



GEBERIT HDPE

THE PROFESSIONAL FOR WASTE DISPOSAL

Wherever high resistance is required for drainage Geberit HDPE is the perfect choice. From enormous temperature change or aggressive waste water to pressure shifts and chemical influences Geberit HDPE will provide the solution.

GEBERIT HDPE DEFIES TEMPERATURES, PRESSURE AND AGGRESSIVE MEDIA

The Geberit HDPE drainage system is manufactured using high density polyethylene (PE-HD) a robust piping material. It is suitable for a number of uses such as industry, commerce, laboratories, for underground installation, in concrete or bridge buildings as well as for house drainage. Hot water does not affect the material at temperatures of up to 80 °C or even up to 100 °C for short periods and without mechanical load. It is resistant against around 95% of all commercially available alkalis, acids and chemicals.

The pipes and fittings also withstand shocks, drops, impacts or pressures of up to 1.5 bar without breakage or permanent deformation. The plastic used is environmentally friendly and 100% recyclable. No toxic emissions are released during its processing or in the event of a fire.

GEBERIT HDPE - CONNECTIONS WITH LONG-TERM STABILITY

Geberit HDPE pipes are available in dimensions ranging from DN 30 to DN 300 and in a wide range of fittings. The pipes and fittings can be connected using butt-welding, electrofusion welding, screw connections or flanges, depending on the purpose. Geberit HDPE pipes and fittings are seamlessly integrated in the Geberit system with its fire protection, roof drainage and industrial systems and can be combined with these without difficulty.

← Fittings and connections for a wide range of applications.

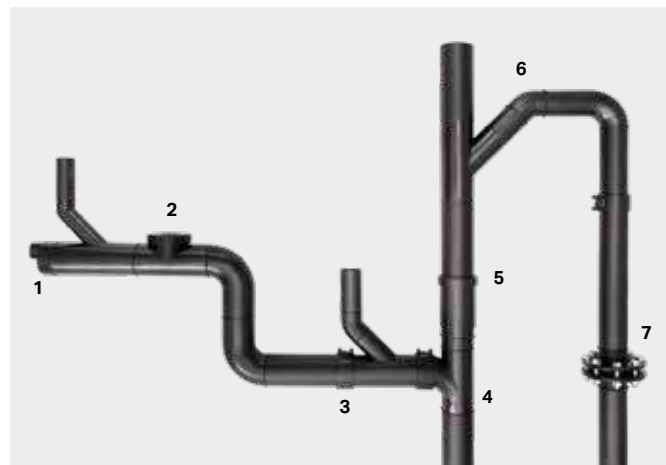

- 1 Eccentric reducer
- 2 Access cap for cleaning
- 3 Electrofusion coupling
- 4 Y - branch swept-entry
- 5 Expansion socket
- 6 Butt welding
- 7 Flange connection



GEBERIT CONNECTION TECHNOLOGY

FOR AN EASY, FAST AND RELIABLE INSTALLATION

Connection technologies in industrial applications must be especially reliable. They ensure that operation is without problems and safe for employees and goods.

THREE CONNECTING SYSTEMS FOR ALL KINDS OF APPLICATIONS

Safe, stable and permanently leakproof connections are the overriding goal in all areas of industrial pipe installation. Geberit relies on three connection technologies. Economical and fast press fitting technology that is certified safe is used in supply systems made of metal and composite pipes.

The Geberit HDPE drainage system is connected together by a simple plastic welding process using electrofusion couplings or by bolting together for a lengthways non-positive connection. As a result connections can be created in the shortest possible time and systems are reliably leakproof. They also offer convincing properties in regards to impact resistance and high load bearing capacity whilst being unremovable, corrosion-resistant and fire-resistant. Connection technologies can also be combined within an application.

PRESSING: THE RIGHT TECHNOLOGY FOR EVERY APPLICATION

Geberit provide pressing tools for pressing systems in 12-108mm. Hand-operated pressing tools are suitable for simple applications, whereas pressing tools with highly efficient electro-hydraulic functions are recommended for quick and efficient results on all dimensions.

ELECTROFUSION WELDING: QUICK AND RELIABLE

The Geberit HDPE drainage system can be permanently connected by electrofusion welding. Chamfering and welding are performed with one tool.

WHY PRESS?

Wherever speed is of the essence and safety is the highest priority. Wherever efficiency matters and cost saving counts. Whatever the installation, Mapress offers complete flexibility, absolute reliability and a seal you can be totally sure of.



↓
Geberit HDPE connection technologies include bolting, butt welding or electrofusion.



- Three different connection technologies
- Optimally coordinated system of press fitting and pressing tool, seal ring, system pipe
- High level of flexibility due to wide range of fittings
- Outstandingly suitable for prefabrication



↑
Even greater power.
Geberit ACO203 PLUS & ECO203 pressing tools
- with and without rechargeable battery.

GEBERIT MAPRESS

CONNECTION

EQUIPMENT NEEDED

TOOL - ACO103 PLUS



For sizes 12-35mm.

TOOL - ACO203 PLUS



For sizes 12-66.7mm for copper and 12-54mm for carbon and stainless steel.

TOOL - ACO203XL PLUS



For all sizes (12-108mm)

OTHER TOOLS ALSO AVAILABLE

DEBURRER



Ensures no sharp edges on the pipework to protect seal.

INSERTION DEPTH MARKER



Ensure pipe insertion depth is correct.

PIPE CUTTER



For pipes from 12-54mm.

JAW



Used with the appropriate tool, from 12-35mm.

COLLAR AND ADAPTER



For the larger sizes, 35-108mm. 108mm fittings require two adapters.

SIX STAGES OF PRESSING

CUT AND DEBURR PIPE



Cut the pipe to length and deburr inside and out so as not to damage the seal ring. Clean chips from the pipe end.

MARK INSERTION DEPTH



To ensure the pipe is fully inserted before pressing. Gives visual security. This is very important!

PREPARE THE FITTING



Remove the protection plug and visually check the seal ring.

INSERT PIPE INTO FITTING



Ensure the insertion depth is met, this is very important.

PRESS



Must use correctly sized jaw/collar. Fittings must be aligned correctly in jaw/collar. Ensure insertion depth is met before pressing!

REMOVE PRESSING INDICATOR



Remove pressing indicator. Check the correct insertion depth has been met.

For sizes 42mm and above you will need to use a collar and adapter for further instructions please refer to the Supply Systems Installation Guide or speak to your local Geberit representative.

For further installation instruction please contact your local representative or call our literature line to request an installation guide on 0800 007 5153

INDUSTRY APPLICATIONS

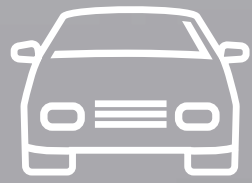

AUTOMOTIVE



FOOD & BEVERAGE



PLANT & MACHINERY



CHEMICAL &
PHARMACEUTICAL



SHIPBUILDING &
OFFSHORE



ENERGY

 **GEBERIT**

AUTOMOTIVE

THE DESIGN, DEVELOPMENT AND MANUFACTURING OF MOTOR VEHICLES

The modern automotive production and components industry requires a large range of clean, safe and flexible piping systems; from process lines to transporting liquid and gas materials, to filling the vehicles with operating liquids or for supply of the production robots, machines and plant. Construction processes in the automotive industry are already highly optimised, but the modern and flexible production can be enhanced by the innovative connection technologies of Geberit Mapress and Geberit Mepla press connection systems.

CLEANER, MORE FLEXIBLE PIPING SYSTEMS FOR VEHICLE PRODUCTION

The breadth of supply systems required in the automotive industry ranges from water supply, process water and chilled water for welding robots to filling lines for operating liquids in the new vehicles produced such as fuel, brake fluid, screen wash or anti-freeze. Automotive producers and delivers also need piping systems for compressed air supply for work and control air as well as for fire protection systems. For all the challenges in automotive production, Geberit offers safer, cleaner and more flexibly installed solutions with its multi-faceted press systems - Geberit Mapress and Geberit Mepla. Compared to welding, Geberit press connection systems clearly reduce the down time of the equipment during installation and maintenance and does not require hot works.

INTERNATIONAL STANDARDS AND APPROVALS FOR A WIDE SPECTRUM OF GEBERIT MAPRESS

Geberit Mapress press fittings and system pipes are available in the silicone free materials stainless steel and carbon steel. Geberit Mapress is suitable for all materials in the process lines within the automotive industry. The press connection system can be installed without causing a fire risk, because hot work is not required

- Geberit Mapress and Geberit Mepla - two supply systems for all applications
- Suitable for numerous process lines in automobile production
- Silicone-free pipes and fittings
- Free from substances that constrain from painting
- Highly cost effective in plant through reduction of down time
- Cost reduction through fast, clean and flexible assembly
- Cold pressed, safe connections without threading, soldering, brazing or welding



OPERATING PRESSURES

PRESS	MAXIMUM PRESSURE [BAR]*					
	HEXAGONAL PRESS		LEMON-SHAPE COMPRESSION		HCPS	
Diameter (mm)	Mapress Stainless Steel	Mapress Carbon Steel	Mapress Stainless Steel	Mapress Carbon Steel	Mapress Stainless Steel	Mapress Carbon Steel
	12	75	40	-	-	-
15	63	40	-	-	-	-
18	63	40	-	-	-	-
22	40	25	-	-	-	-
28	25	25	-	-	-	-
35	16	16	25	25	-	-
42	-	-	25	16	-	-
54	-	-	25	16	-	-
76.1	-	-	16	12	16	16
88.9	-	-	12	12	16	12
108	-	-	12	12	16	12

*Any pressure above 16 bar should be confirmed by request.

SEAL RING APPLICATIONS

APPLICATION	Drainage	Solvents	Acetylene	Inert gases	Hydrogen	Oxygen	Industrial vacuum	Compressed air	Control air	Windscreens washer fluid	Frost protection	Cooling liquid	Urea (ad blue)	Diesel, biodiesel	Premium, regular petrol	Brake fluid dot 4	Test oils (mineral oil base)	Mineral oils sae	Oil-water-emulsions	Extinguisher pipes	Sprinkler systems	Ve water	Process water	Coolants	Potable water
	GEBERIT MAPRESS SEAL RING																								
CIIR - black	■	■	■	■	■	■	■	■	■	■	■	■	■	■	■	■	■	■	■	■	■	■	■	■	■
FKM - blue	■						■	■			■	■	■	■			■	■	■		■	■	■	■	
EPDM - black								■	■													■*	■*	■	■

■ Geberit Mapress Stainless Steel ■ Geberit Mapress Carbon Steel ■ Geberit Mepla

*Red brass fittings emit metal ions into water. They aren't suitable for deionised water transport unless there is additional treatment at the outlet.

Maximum operating pressure, see Vd-TÜV admission table



FOOD AND BEVERAGE

GROWING, MANUFACTURING, PROCESSING AND STORING THE FOODS OF THE WORLD

In hygienically sensitive areas of food industries many different process lines are required. The innovative Geberit Mapress stainless steel press connection system fulfils the strict hygienic challenges of food industries for a variety of applications. In addition, Geberit Mapress stainless steel supply systems can be disinfected chemically or thermally.

MEETING STRINGENT HYGIENE REQUIREMENTS

Geberit Stainless Steel press connection systems fulfil the strict hygiene requirements for the process lines for the production of food and beverages. Geberit Mapress and Geberit Mepla guarantee a safe and clean installation.

Whether in breweries, cheese dairies and creameries, sugar factories or abattoirs, Geberit's solutions are ideal for process lines for cleaning & disinfecting products, saturated steam for disinfection & sterilisation and for various packaging methods including vacuum and gases including technical gases like hydrogen, nitrogen and oxygen.

GEBERIT MAPRESS STAINLESS STEEL FOR CLEANING AND DISINFECTION MATERIALS

Geberit Mapress press fittings and system pipe are used in the pharmaceutical and food industry in corrosion resistant stainless steel. Four different seal rings and international approvals offer a wide spectrum of use of the Geberit Mapress system for process lines for cleaning and disinfection products or for saturated steam. The clean installation technology takes into account the required installation hygiene, as stainless steel does not influence the purity of the gases used. All supply systems lines can be chemically or thermally disinfected.

GEBERIT MEPLA IN THE FOOD INDUSTRIES

The multilayer pipe system Geberit Mepla can be used in the food industries for compressed air, potable water installations and for heating. Geberit Mepla lends itself to safe, clean and flexible installation. All Geberit Mepla fittings and system pipes are closed with caps and delivered individually packed. This way, the noted hygiene in installation is maintained. Also, installation times are clearly reduced through reduction of down time which is highly cost effective in plant.

- Hygienic harmless materials fulfil the hygienic challenges of the food industry
- Geberit system pipes and press fittings are individually capped
- Clean installation technology through cold presses without soft solder, hard solder or welding
- Geberit Mapress Stainless Steel supply systems can be easily disinfected chemically or thermally
- The high molybdenum content of Geberit Mapress Stainless Steel components ensure excellent corrosion resistance



OPERATING PRESSURES

PRESS	MAXIMUM PRESSURE [BAR]*					
	HEXAGONAL PRESS		LEMON-SHAPE COMPRESSION		HCPS	
Diameter (mm)	Mapress Stainless Steel	Mapress Carbon Steel	Mapress Stainless Steel	Mapress Carbon Steel	Mapress Stainless Steel	Mapress Carbon Steel
	12	75	40	-	-	-
15	63	40	-	-	-	-
18	63	40	-	-	-	-
22	40	25	-	-	-	-
28	25	25	-	-	-	-
35	16	16	25	25	-	-
42	-	-	25	16	-	-
54	-	-	25	16	-	-
76.1	-	-	16	12	16	16
88.9	-	-	12	12	16	12
108	-	-	12	12	16	12

*Any pressure above 16 bar should be confirmed by request.

SEAL RING APPLICATIONS

APPLICATION	Drainage	Solvents	Acetylene	Inert gases	Hydrogen	Oxygen	Flammable gases (DVGW VP 614)	Industrial vacuum	Compressed air	Control air	Frost protection	Refrigerant (freon)	Extinguisher pipes	Sprinkler systems	VE water	Process water	Coolants	Potable water
	GEBERIT MAPRESS SEAL RING																	
CIIR - black	■	■	■	■	■	■		■	■	■	■		■	■	■	■	■	■
FKM - blue	■							■	■		■			■	■	■	■	
HNBR - yellow							■					■						
EPDM - black									■	■					■	■	■	■

■ Geberit Mapress Stainless Steel ■ Geberit Mepla

*Red brass fittings emit metal ions into water. They aren't suitable for deionised water transport unless there is additional treatment at the outlet.

Maximum operating pressure, see Vd-TÜV admission table



PLANT AND MACHINERY

A LARGE SCALE PRODUCTION OF PARTS AND GOODS ASSEMBLED BY MACHINE

In the plant and machinery industry tight, stable pipe connections are required for various special media, for example mineral oils and motor fuels, compressed air, fuel gases, inert gases and special technical gases like oxygen. In combined heat and power plants, steelworks or paper factories, Geberit supply systems can be used for operating and chilled water, purified water, process water, saturated steam and condensate lines, and also sprinkler and fire extinguishing systems.

STABLE, VARIED AND SECURE SOLUTIONS FOR INDUSTRY

The wide range of plant and machinery industries need supply systems for the supply of cooling substances, operating and chilled water, condensate lines, from compressed air control, lubricants and oil to inert gases and technical gases. Further piping systems for compressed air delivery or for breathable air as well as for sprinkler systems, fire extinguishing lines or hydrants are also required. For these challenges in the manufacturing industry, Geberit Mapress and Geberit Mepla press fitting systems offer fast, safe and clean solutions. Through the flexible use, down time in the plant and machinery industry can be clearly reduced.

GEBERIT MAPRESS IS TÜV APPROVED AND ALLOWED FOR MANY MEDIA, INCLUDING OXYGEN AND HYDROGEN

The Geberit Mapress press connection system offers an extensive fitting range in the materials stainless steel and unalloyed carbon steel. Different seal rings, TÜV approved, made to international standards and conformities widen the spectrum of use of Geberit Mapress Stainless Steel to over 200 chemicals and special media. Geberit Mapress is installed easily and economically, with no danger and without open flames. Where previously welding was used, today clean and long lasting safe pipelines can be installed with Geberit press connection systems in the shortest time.

GEBERIT MEPLA - FLEXIBLE IN MANY INDUSTRIAL APPLICATIONS

Geberit Mepla is also suitable in the process industry for an easy and fast installation technology. The multilayer pipe system can be used for compressed air, cooling systems or for clean and safe hot and cold water installations and heating.

→ Geberit Mapress is TÜV approved and suitable for special media and gases like oxygen, hydrogen and acetylene

→ Geberit Mapress is capable of handling over 200 chemicals

→ Cost reduction through fast, clean and flexible installation

→ High plant availability through reduction of down time

→ Extensive fitting range in various materials

→ Clean cold pressing system without fire risk, also ideal for repairs and extensions

OPERATING PRESSURES

PRESS	MAXIMUM PRESSURE [BAR]*					
	HEXAGONAL PRESS		LEMON-SHAPE COMPRESSION		HCPS	
Diameter (mm)	Mapress Stainless Steel	Mapress Carbon Steel	Mapress Stainless Steel	Mapress Carbon Steel	Mapress Stainless Steel	Mapress Carbon Steel
	12	75	40	-	-	-
15	63	40	-	-	-	-
18	63	40	-	-	-	-
22	40	25	-	-	-	-
28	25	25	-	-	-	-
35	16	16	25	25	-	-
42	-	-	25	16	-	-
54	-	-	25	16	-	-
76.1	-	-	16	12	16	16
88.9	-	-	12	12	16	12
108	-	-	12	12	16	12

*Any pressure above 16 bar should be confirmed by request.

SEAL RING APPLICATIONS

APPLICATION	Drainage	Solvents	Acetylene	Inert gases	Hydrogen	Oxygen	Burnable gases (DVGW VP 614)	Industrial vacuum	Compressed air	Control air	Frost protection	Refrigerant (Freon)	Cooling lubricant	Mineral oils SAE	Oil-water-emulsions	Extinguisher pipes	Sprinkler systems	VE water	Process water	Coolants	Potable water	
	GEBERIT MAPRESS SEAL RING																					
CIIR - black	■	■	■	■	■	■		■	■	■	■		■			■	■	■	■	■	■	■
FKM - blue	■							■	■		■		■	■	■		■	■	■	■	■	
HNBR - yellow							■					■										
EPDM - black									■	■								■*	■*	■	■	■

■ Geberit Mapress Stainless Steel ■ Geberit Mapress Carbon Steel ■ Geberit Mepla

*Red brass fittings emit metal ions into water. They aren't suitable for deionised water transport unless there is additional treatment at the outlet.

Maximum operating pressure, see Vd-TÜV admission table



CHEMICAL AND PHARMACEUTICAL

THE DESIGN AND DEVELOPMENT OF INDUSTRIAL CHEMICALS AND MEDICATIONS

Stable, reliable pipe connections are essential in chemical and pharmaceutical production. Geberit supply systems can be used to transport chilled water, processed water & process water as well as condensate lines, sprinkler and fire extinguisher systems or hydrants, mineral oils & fuels, compressed air, fuel gases, inert gases and technical gases. Geberit Mapress press connection system is also suitable for the supply of chemicals, as long as Geberit's approval is given. For safe waste disposal Geberit HDPE provides the perfect drainage solution for the chemical and pharmaceutical industry.

VERSATILE PRESS CONNECTION SYSTEMS FOR THE SUPPLY OF CHEMICALS

Required in the modern chemical industry there are a great breadth of applications for press connection systems in supply and drainage. There are coolants, compressed gases, chilled and heated water, potable water, lubricants and oil as well as fire protection systems. Further pipelines for the supply of compressed air, for technical gases and for process, deionised and chilled water are required. For all these challenges in the chemical industry Geberit offers the versatile press connection systems Geberit Mapress and Geberit Mepla which provide flexible, clean and secure solutions. Where previously welding was used, today clean and long lasting safe pipelines can be installed with Geberit press connection systems in the shortest time. The reduction of installation times provides for a higher plant availability.

GEBERIT MAPRESS - APPROVED FOR USE WITH MORE THAN 200 CHEMICALS

With the press connection system Geberit Mapress, the corrosion resistant materials stainless steel and unalloyed carbon steel is suitable for a multitude of approved and permitted media. Various seal rings, TÜV release, international approvals and certificates of conformity offer a wide spectrum of usage of the Geberit Mapress system, ranging from waters, compressed air, oils and fuels, through to inert and technical gases, to over 200 chemicals. Because the Geberit press connection system works without soldering and welding, it can be safely installed in potentially explosive areas.

GEBERIT MEPLA IS SUITABLE FOR THE CHEMICAL INDUSTRY

The multilayer press system Geberit Mepla can be used in the chemical industry for compressed air, cooling systems or for the hot and cold water installations and heating.

- Reduction of the installation time through fast, clean and flexible installation
- High plant availability due to the minimisation of downtime
- Corrosion resistant materials like Mapress Stainless Steel
- Industry-safe connection technology through factory made fittings programme
- Geberit Mapress is TÜV approved and allowed for over 200 chemicals
- Safe working in hazardous areas, due to cold pressed safe connections

OPERATING PRESSURES

PRESS	MAXIMUM PRESSURE [BAR] ¹					
	HEXAGONAL PRESS		LEMON-SHAPE COMPRESSION		HCPS	
Diameter (mm)	Mapress Stainless Steel	Mapress Carbon Steel	Mapress Stainless Steel	Mapress Carbon Steel	Mapress Stainless Steel	Mapress Carbon Steel
	12	75	40	-	-	-
15	63	40	-	-	-	-
18	63	40	-	-	-	-
22	40	25	-	-	-	-
28	25	25	-	-	-	-
35	16	16	25	25	-	-
42	-	-	25	16	-	-
54	-	-	25	16	-	-
76.1	-	-	16	12	16	16
88.9	-	-	12	12	16	12
108	-	-	12	12	16	12

¹Any pressure above 16 bar should be confirmed by request.

SEAL RING APPLICATIONS

APPLICATION	Drainage	Solvents	Acetylene	Inert gases	Hydrogen	Oxygen	Burnable gases (DVGW VP 614)	Industrial vacuum	Compressed air	Control air	Frost protection	Refrigerant (Freon)	Cooling lubricant	Mineral oils SAE	Oil-water-emulsions	Extinguisher pipes	Sprinkler systems	VE water	Process water	Coolants	Potable water	
	GEBERIT MAPRESS SEAL RING																					
CIIR - black	■	■	■	■	■	■		■	■	■	■		■			■	■	■	■	■	■	■
FKM - blue	■							■	■		■		■	■	■		■	■	■	■	■	
HNBR - yellow							■					■										
EPDM - black									■	■								■*	■*	■	■	

■ Geberit Mapress Stainless Steel ■ Geberit Mapress Carbon Steel ■ Geberit Mepla

*Red brass fittings emit metal ions into water. They aren't suitable for deionised water transport unless there is additional treatment at the outlet.

Maximum operating pressure, see Vd-TÜV admission table



SHIPBUILDING AND OFFSHORE

CONSTRUCTING SHIPS, YACHTS, FLOATING VESSELS AND OFFSHORE CONSTRUCTIONS

From private yachts or passenger vessels to offshore projects, Geberit offers many solutions for supplying and draining off various medias in shipbuilding. The Geberit advantage for shipbuilders is thin-walled system pipes of metal or plastic that can be pressed into a system to significantly reduce the overall weight. A variety of media, including fresh water, seawater, compressed air, fuels and oils can be transported through our systems.

GEBERIT PRESS FITTING SYSTEMS HAVE CIVILIAN AND MILITARY APPROVALS

Typical operational areas for reliable, long life pipes within shipbuilding are potable water installations, fire protection systems, engine room systems with pipes for water emulsions/oil emulsions, mineral oils and lubricating oils, heating and cooling systems with refrigerant and antifreeze as well as compressed air and inert gases. A variety of media can be distributed within Geberit piping systems for shipbuilding, including cooling water, process water, demineralised water as well as sea water and bilge water.

The Geberit Mapress materials of stainless steel, carbon steel, copper and a sea water resistant copper-nickel-iron-alloy (CuNiFe) satisfy the requirements of the marine industry and have acquired international civilian and military authorisations from the most important shipping authorities.

GEBERIT MAPRESS CUNIFE - FOR THE SEA WATER COOLING AND SPRINKLER SYSTEMS

Geberit Mapress CuNiFe is a salt water-resistant copper-nickel-iron alloy (CuNi10Fe1, 6Mn) and has proven itself over many years within shipbuilding, for pipelines carrying salt water. It eliminates the need for welding meaning no fire hazard and effectively prevents corrosion. The Geberit Mapress system is used in shipbuilding for engine room systems, the supply of service water, pool water and heating water. Geberit Mapress CuNiFe is, up to a chloride content of 30 g/l, sea water resistant and approved for sea water cooling supply and is also certified for sea water-powered sprinkler systems.

THE GEBERIT MEPLA METAL COMPOSITE PIPE SYSTEM FOR HOT AND COLD DRINKING WATER

In using Geberit Mepla press fitting pipes and fittings in shipbuilding, large weight savings can be achieved. Geberit Mepla is a lighter material which is a huge advantage within the shipbuilding industry.

→ Internationally recognised approvals from shipping and military authorities

→ A piping system for various applications in shipbuilding with a comprehensive range of different materials

→ Geberit Mapress pipe systems and fittings can save up to 50 percent in weight compared to similar materials

→ Cost reduction through easy and quick installation technique

→ No fire hazard, as cold pressing system and processing without open flame

→ Suitable for new build and renovation, without fire hazard from welding and brazing



↓ Geberit supply systems are available for a wide range of applications for shipbuilding

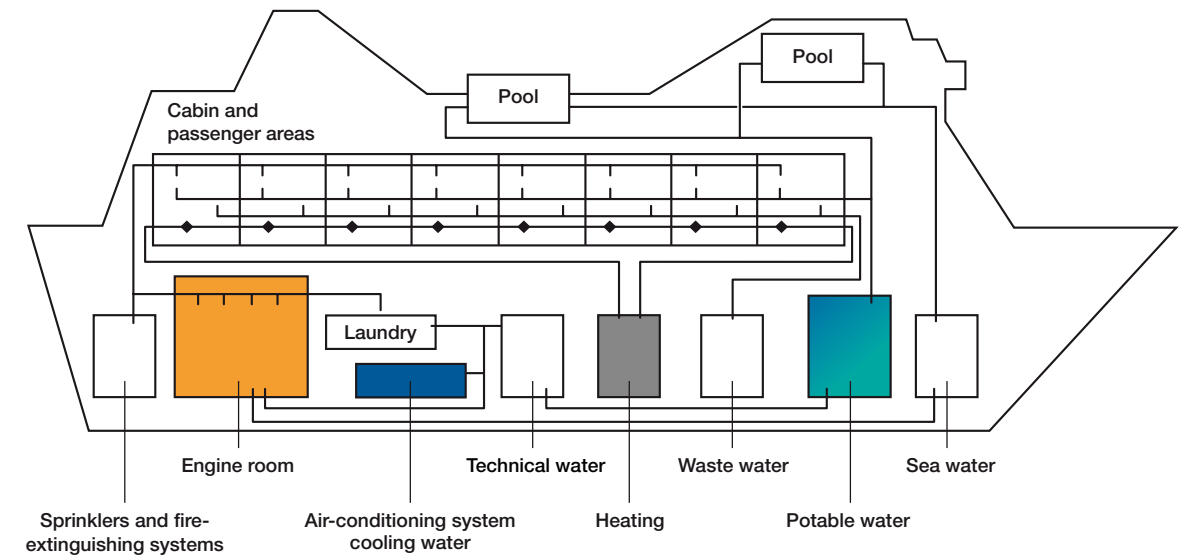

SEAL RING APPLICATIONS

APPLICATION	Inert gases	Compressed air	Antifreeze	Refrigerant (Freon)	Lubricant	Mineral oils SAE	Oil-water emulsions	Extinguisher pipes	Sprinkler systems	Bilge water	Sea water	Demineralised water	Process water	Coolants	Potable water
CIIR - black	■	■	■	□				■	■			■	■	■	■
FKM - blue		■	■		■	■	■		■		■				
HNBR - yellow				■											
EPDM - black		■									■				■

■ Geberit Mapress Stainless Steel □ Geberit Mapress Copper ■ Geberit Mepla ■ Geberit Mapress Carbon Steel ■ Geberit Mapress CuNiFe

Maximum operating pressure, see Vd-TÜV admission table



ENERGY

THE PROCESSING OF FUELS AND OILS TO SUPPLY ENERGY TO BUSINESS & CONSUMERS

Geberit Mapress in stainless steel and carbon steel is suitable for transporting fuels and oils. Our pressing systems have been in use in fuel and oil supply pipes for over 15 years, particularly in power plants, workshops and in petrol stations. The permanently high tightness of the connection and its quick and simple installation technology mean that Geberit Mapress is a state-of-the-art, high-quality and economical connection technology.

GEBERIT MAPRESS STAINLESS STEEL

System pipes and pressfittings made of high-alloy, austenitic, stainless CrNiMo steel with material number 1.4401 in accordance with BS EN 10088, with dimensions d12–108 with TÜV component ID TÜV.A.271-07.

GEBERIT MAPRESS CARBON STEEL

Pressfittings made of non-alloy carbon steel E195 with material number 1.0034 in accordance with BS EN 10305, outside zinc-plated, in conjunction with system pipe made of non-alloy carbon steel E195 with material number 1.0034 in accordance with BS EN 10305, outside zinc-plated with dimensions d12–108 or polypropylene (PP) unjacketed with dimensions d12–54 in accordance with BS EN 10305 with TÜV component ID TÜV.A.271-07.

- Highly cost effective in plant through reduction of down time
- Corrosion resistant materials like Geberit Mapress Stainless Steel
- No fire hazard, as no hot works are required to install the system
- Clean, safe connections without threading, soldering, brazing or welding
- Ability to be used on a variety of different fuels and oils
- Geberit Mapress is TÜV approved and allowed for over 200 chemicals



OPERATING PRESSURES

PRESS	MAXIMUM PRESSURE [BAR] ¹					
	HEXAGONAL PRESS		LEMON-SHAPE COMPRESSION		HCPS	
	Mapress Stainless Steel	Mapress Carbon Steel	Mapress Stainless Steel	Mapress Carbon Steel	Mapress Stainless Steel	Mapress Carbon Steel
12	75	40	-	-	-	-
15	63	40	-	-	-	-
18	63	40	-	-	-	-
22	40	25	-	-	-	-
28	25	25	-	-	-	-
35	16	16	25	25	-	-
42	-	-	25	16	-	-
54	-	-	25	16	-	-
76.1	-	-	16	12	16	16
88.9	-	-	12	12	16	12
108	-	-	12	12	16	12

¹Any pressure above 16 bar should be confirmed by request.

FUELS AND OILS

		APPLICATION										
		Heating oil/diesel	Biodiesel	Petrol ROZ 95	Petrol ROZ 98	Kerosene	Bioethanol	Methanol	Engine oils (SAE)	Transmission oils (SAE)	Waste oils (SAE)	Urea nitrate, e.g. AdBlue
GEBERIT MAPRESS SEAL RING	Approval in accordance with VdTUV	■	■	■	■	■	■	■	■	■	■	■
	Approval in accordance with DIBt	■	■	■	■	■	■	■	■	■	■	■

■ Geberit Mapress Stainless Steel ■ Geberit Mapress Carbon Steel ■ Geberit Mepla

Pressures in accordance with DIBt: 10/16 bar.
Pressures in accordance with TÜV: stainless steel: d12–28: 25 bar, d35–54: 16 bar, d76.1–108: 12 bar.

Note
The DIBt approval covers the use of Geberit Mapress for oils/fuels up to hazard category A III (flash point > 55 °C). On the basis of the TÜV component certificate and in accordance with the requirements of the Pressure Equipment Directive (PED) and the relevant regulations, e.g. the German Ordinance on Flammable Liquids (VbF) and the adopted Technical Regulations for Flammable Liquids (TRbF), the Geberit Mapress Stainless Steel pressing system can be used for flammable liquids of hazard category A I (flash point < 21 °C) and A II (flash point > 21 °C). Use of the Geberit Mapress pressing system for synthetic oils, brake fluids, cooling lubricants, creep oils and cutting oils must always be approved by Geberit.

Maximum operating pressure, see Vd-TÜV admission table

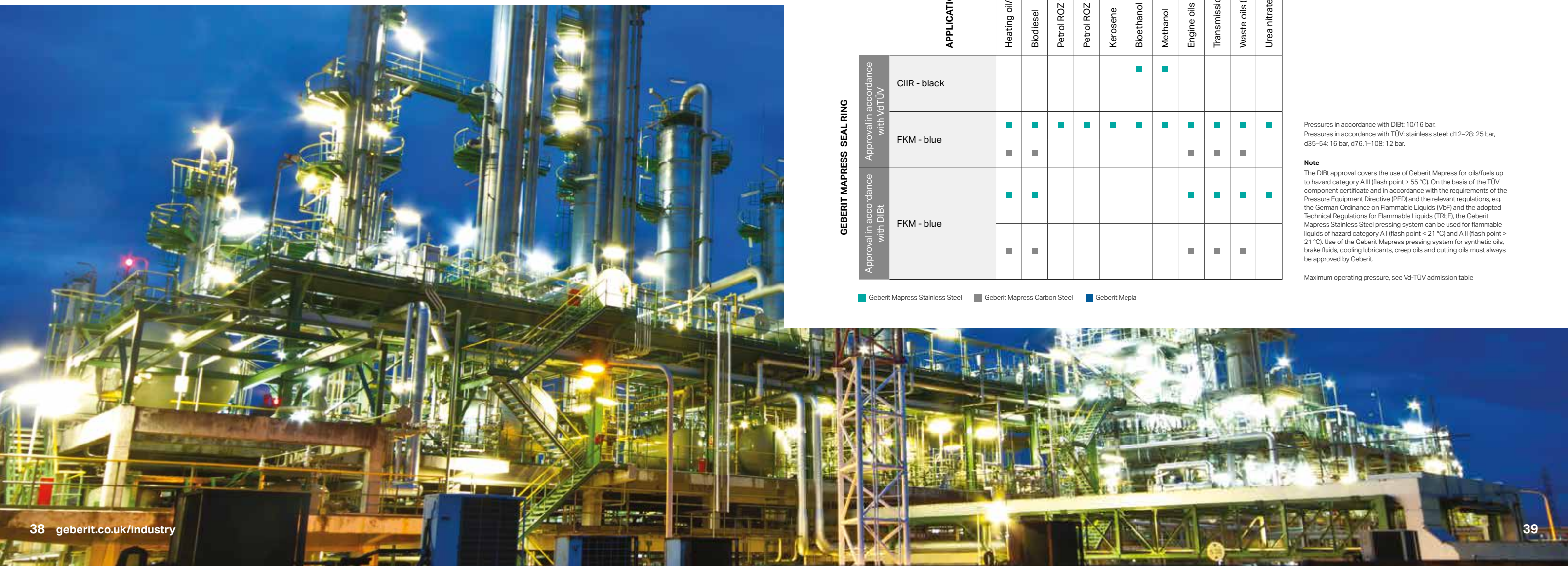

INDUSTRY

CASE STUDIES



AUTOMOTIVE



FOOD & BEVERAGE



PLANT & MACHINERY



CHEMICAL &
PHARMACEUTICAL



SHIPBUILDING &
OFFSHORE



ENERGY

SUPPLYING MAPRESS TO PEAKING POWER PLANTS IN THE UK

LUBRICATION OIL SUPPLIED WITH GEBERIT MAPRESS STAINLESS STEEL FOR GAS TURBINE ENGINES



→ PROJECT INFORMATION

Location: UK

Contractor: MD Lawrence

Project Completion: Ongoing

→ GEBERIT KNOW-HOW

Problem: The need to supply the lubrication oil to the plants gas turbine engines

Solution: Geberit Mapress stainless steel



→ PROJECT OVERVIEW:

The traditional surge in electricity during sporting or historic television events, when households switch on the kettle during a television ad break, can place huge demand on the electrical grid.

Peaking power plants, typically gas turbines, are power stations that provide additional energy during these peak periods. These gas turbine engines can be located in several bespoke containers across a single site.

Contractor MD Lawrence was working on a project to install the pipework at a large peaking power plant in the UK. Matt Lawrence, Director of MD Lawrence, was looking for an innovative and reliable manufacturer to specify the pipework used to supply the lubrication oil for the plant's gas turbine engines.

→ WHY GEBERIT?

Geberit Mapress stainless steel provided the solution for MD Lawrence due to its ease of installation and guaranteed quality.

Offering a much safer alternative to conventional pipework connection methods, Geberit Mapress uses increasingly popular press connection technology. Any connections not pressed during the installation process can be visibly detected during testing. The pressing indicator consists of a thin plastic foil encasing the pressing shoulder, which gives a visible indication of a pressed joint as the foil is removed during correct installation.

Crucially, too, using a pressing solution eliminates the requirement for hot works and, with no cool down period, press fit systems have been proven to take 30% less time to install than their traditional counterparts according to a BRISA report. This can also help to reduce the cost of jobs by approximately 27% compared with screwed steel pipework.

Matt Lawrence explains why Geberit Mapress was the natural choice for MD Lawrence: "We were looking for a solution that would not only be reliable but that would also give us a quick turnaround during the installation process. We needed to keep any downtime to a minimum."

→ DELIVERING THE SOLUTION

Matt believes that the installation benefits of Mapress, as well as Geberit's technical support, were key elements in the successful delivery of the project.

Matt continues: "The installation process of Mapress was a huge factor in our decision to select the product in the first place – it was a much quicker and simpler process than it would have been if we had gone for one of the more traditional jointing alternatives. This saved valuable time and, as a result, we were able to turnaround the project ahead of schedule thanks to this ease of installation.

"This, together with the technical support and service we received from Geberit, played a big part in the success of this project."

Geberit Mapress is available in range of materials including carbon steel, copper, stainless steel, and CuNiFe.

"This, together with the technical support and service we received from Geberit, played a big part in the success of this project."

Matt Lawrence, Director of MD Lawrence

GEBERIT MAPRESS IS A SHIPSHAPE SOLUTION FOR PARKOL MARINE ENGINEERING

WHY PRESS FIT PIPE SYSTEMS ARE SAVING TIME AND IMPROVING STANDARDS FOR BOAT AND SHIP BUILDER



→ PROJECT INFORMATION

Building: Various boats, ships & trawlers

Location: Whitby, North Yorkshire

Contractor: Parkol Marine Engineering

Project Completion: Ongoing

→ GEBERIT KNOW-HOW

Problem: Piping systems for various applications on boats, ships and trawlers

Solution: Geberit Mapress CuNiFe and Geberit Mapress Copper

→ PROJECT OVERVIEW:

Based in Whitby, North Yorkshire, Parkol Marine Engineering is recognised as one of the leading boat, ship and trawler builders in the United Kingdom. It offers a full range of marine engineering services, from new builds to repairs and refurbishment, on an expansive yard which includes building berths and a dry dock.

With any marine engineering project, time is critical. Dry dock space is a valuable commodity and with such tight schedules, any delays can have a serious impact on profitability – not only for the project in question, but for future projects too.

Parkol Marine Engineering turned to the Geberit Mapress press fitting solution to save time and guarantee quality on a wide range of applications across new build and refurbishment projects on boats, ships and trawlers.

→ WHY GEBERIT?

Available in a range of materials including copper, stainless steel, CuNiFe and carbon steel, the Geberit Mapress pressing solution offers quicker installation and a cleaner, neater job, with no need for hot works.

It is designed so that any connections not pressed during installation can be visibly detected during testing. The pressing indicator consists of a thin plastic foil encasing the pressing shoulder, which gives a visible indication of a pressed joint as the foil is removed during correct installation.

With no hot works and therefore no subsequent cooling down period, Parkol's engineers can fit pipework easier and quicker within the tight confines of a shipyard, dry dock or the deck of the ship itself. There is also no need for lubrication and greater reliability.

Crucially, press fit systems have been proven to take 30% less time to install than their traditional counterparts according to a BRSIA report, helping reduce the cost of jobs by approximately 27% compared with screwed steel pipework. It's easy to see why Mapress has become the pipe fitting solution of choice across all aspects of Parkol's new build and refurbishment projects.



"Geberit Mapress is quicker to install, with no welding and less mess. It's also reliable, with no leaks. It's the perfect solution for a wide range of applications across our projects."

John Clarkson, Piping Supervisor.

KEEPING STANDARDS HIGH FOR AWARD WINNING FOOD MANUFACTURER

HYGIENE LINES INSTALLED USING GEBERIT MAPRESS TO ENSURE ULTIMATE HYGIENE IN A SENSITIVE ENVIRONMENT



→ PROJECT OVERVIEW:

Greencore Group plc is a leading international manufacturer of convenience foods, supplying a wide range of chilled, frozen and ambient foods to some of the most successful retail and food service customers in the UK and US.

Its factory at Park Royal in London is part of Greencore's 'Food to Go' business, manufacturing pre-packed sandwiches for major supermarket and high street chains, petrol forecourts and convenience stores. A 'Sammie' (The British Sandwich Association) award winning facility, the Park Royal factory has achieved BRC AA* accreditation, a leading safety and quality certification programme used by more than 23,000 certified suppliers in 123 countries.

In order to maintain its high standards, Greencore began work in 2016 on upgrading Park Royal. Contractors, Miramar Engineering, installed a new tray wash machine in a refurbished area of the factory and chose Geberit Mapress Stainless Steel to deliver steam and air, plus hot and cold water - the first of five phases of works which will utilise the pressing solution.

Twelve months later, Geberit Mapress was once again fitted - this time, as part of the hygiene lines used to deliver clean-down chemicals to mixing stations across the factory. The pipework was chosen as part of a permanent system in order to make a safer working environment by putting an end to the use of chemical drums being wheeled onto the shop floor, while minimising the need for long hoses during surface washing.

→ WHY GEBERIT?

Greg Pelling, from Miramar Engineering, explains why Geberit Mapress was chosen for this next phase of works:

"With experience using Geberit Mapress Stainless Steel in the first part of this project, we were confident that it met the quality and safety requirements required."

"A key element was its compatibility with chemicals; we used the black O rings which can withstand hazardous substances. The fact no welding was required meant we could carry out works during operational hours, minimising the disruption caused. Pressing is also extremely quick and relatively easy to master - we've had everyone from our Head of Mechanical Engineering to second and first year apprentices installing the system."

"The job went really well. Greencore was impressed with the installation speed, quality and 25 year Warranty Geberit Mapress offers. It is now specifying it for all phases of works at Park Royal, plus expansion plans at other factories."



→ PROJECT INFORMATION

Building: Greencore Group PLC Factory

Location: Park Royal, London

Contractor: Miramar Engineering

Project Completion: September 2017

→ GEBERIT KNOW-HOW

Problem: A solution for hygiene lines

Solution: Geberit Mapress stainless steel

"With experience using Geberit Mapress Stainless Steel in the first part of this project, we were confident that it met the quality and safety requirements required."

Greg Pelling, Company Director, Miramar Engineering.

GLOBAL MANUFACTURER CHOOSES GEBERIT MAPRESS

A SMURFIT KAPPA FACTORY IN NORWICH USES GEBERIT
MAPRESS TO TRANSPORT LIQUID GLUE



→ PROJECT INFORMATION

Building: Smurfit Kappa cardboard factory

Location: Fishersgate

Installer: GRS Mechanical

Project Completion: January 2016

→ GEBERIT KNOW-HOW

Problem: A pipe system to transport liquid glue for production, but can also be flushed out

Solution: Geberit Mapress Stainless Steel

→ PROJECT OVERVIEW:

Smurfit Kappa, the leading global packaging manufacturer, supplies a range of cardboard-based products, including packaging for the retail, food, postal and industrial sectors. Its factory in Fishersgate required new piping to transport liquid glue (a galvanised starch line), used to bond corrugated cardboard together; Smurfit Kappa's primary product.

The replacement galvanised starch line needed air driven pumps, tappings and the ability to be cleaned with warm water after production so it remains functional. GRS Mechanical removed the majority of the existing 2" galvanised steel pipework, which had become clogged with glue, replacing it with 54mm Geberit Mapress Stainless Steel.

→ WHY GEBERIT?

Geberit Mapress was chosen due to its ease of installation and the fact no hot works are required in its fitting; essential in a highly flammable cardboard factory. Geberit Mapress can also be prefabricated and is light to install, achieving a neat installation. Stainless steel is strong and unaffected by the glue, with FKM seal rings ensuring exceptional leak protection.

Gary Smith, from GRS Mechanical, said "The success of the new galvanised starch line at the Fishersgate factory has meant that GRS mechanical will be installing the same solution at another Smurfit Kappa site, on Jupiter road in Norwich. The installation was easy and straightforward, GRS uses Geberit Mapress regularly, so is very familiar with the pressing solution."



**"The installation was easy and straightforward,
GRS uses Geberit Mapress regularly, so is very familiar
with the pressing solution."**

Gary Smith, GRS Mechanical.

GEBERIT MAPRESS DELIVERS THE PIPING SOLUTION FOR DATA CENTRE

GEBERIT HAVE DEVELOPED A BUNDED PIPE SOLUTION
WITH FSS IN CENTRAL LONDON



→ PROJECT OVERVIEW:

A Data Centre in Central London required new bulk tanks, polishing systems and pipework, fully linking with the existing single skin welded steel pipe system. Tanks had to be drained and de-gassed, with temporary tanks installed and out of hours works required, making the project a particularly costly one.

Fuel Storage Solutions (FSS) historically used compression, single skin, stainless steel pipe on similar jobs, but this particular application required bundled pipe. FSS worked with Geberit in Germany to develop a suitable pipe, complete with a ten year warranty. FSS is now the only company in the world that can offer bundled press-fit pipe of this type and the only company approved by Geberit to fit it.

→ WHY GEBERIT?

With Geberit Mapress, no hot works are required, so for this particular project the installation was completed without the need to empty tanks and put in temporary storage facilities. Any future modifications can be easily done; drain the line or attach a new fitting, for example.

The line was taken from the bulk tanks all the way to the day tank in one continuous run, monitored 24/7 and linked into the BMS, pumps or solenoid valve on the bulk tank. If a leak is detected the line will stop taking-in oil.

Jonathan Barnett, Managing Director for FSS, said: "In our opinion, Geberit Mapress is vastly superior to welded or threaded steel, presenting a better and cheaper alternative. Now, combined with bunding, we have developed with Geberit a unique product that specifically meets the challenges of our sector."

"FSS has since been asked to look at using this new piping solution for water, coolants, gases and waste products in sensitive areas where leaking is not an option."

Jonathan Barnett, Managing Director for FSS.

→ PROJECT INFORMATION

Building: Data Centre

Location: Central London

Installer: FSS (Fuel Storage Solutions)

Project Completion: July 2013

→ GEBERIT KNOW-HOW

Problem: Required a bundled piping solution to transport fuel

Solution: Bespoke, bundled Geberit Mapress Stainless Steel

WATER TREATMENT WORKS **GETS THE GEBERIT TREATMENT**

GEBERIT MAPRESS STAINLESS STEEL PROVIDES COMPRESSED AIR LINES TO HELP PROCESS WATER



→ PROJECT OVERVIEW:

A water treatment works in the Midlands required pipework repair for the compressed air ozone system injected into the plant's drinking water supplies.

Two oil-free compressors were linked to two 3,000 litre galvanised air receivers and then back to refrigerant dryers and desiccant dryers. This resulted in clean air that was injected in mains water.

The compressed air pipework was constructed using Geberit Mapress stainless steel 88.9mm, using a variety of bends, tees, flanges and couplings. The equipment also needed to be cooled via chilled water; this system was also constructed out of Geberit Mapress stainless steel, this time at 54mm.

→ WHY GEBERIT?

Gary Smith, from GRS Mechanical explained the challenges of working in a fully operational water treatment works:

"The existing plant is dairy welded stainless steel pipework and we had to work with this system, fitting new pipework to the old. We were only able to use existing valves, placing limitations on the install.

"The biggest challenge, however, was that the site is operational 24/7, with no shut down periods, so all of the installation had to fit around a fully functioning water treatment plant. The fact Geberit Mapress has no need for hot works was ideal, allowing the plant to be kept running throughout the repairs. Avoiding downtime was a real bonus for the customer – we showed them the works we had completed using Geberit Mapress at other plants to convince them of its benefits.

"Apart from the ease of installation that Geberit Mapress offered, time was also saved on the job as there was no need for off-site fabrication. Once the plant and tooling was set up, all works could be carried out on site to suit any existing layouts.

"Another key factor was hygiene. In this instance, Geberit Mapress is carrying super clean compressed air for the ozone plant associated with drinking water."

Gary concluded: "GRS Mechanical has a long running relationship with Geberit. Our installers are fully trained to use Mapress and we find the pressing solution ideal for projects such as this – it's extremely easy to use, quick to install and the no hot works factor makes it suitable for challenging environments; particularly alongside existing systems where downtime is not an option."

"Another key factor was hygiene. In this instance, Geberit Mapress is carrying super clean compressed air for the ozone plant associated with drinking water."

Gary Smith, Company Director, GRS Mechanical.



→ PROJECT INFORMATION

Building: Midlands Water Treatment Works

Contractor: GRS Mechanical

Project Completion: November 2017

→ GEBERIT KNOW-HOW

Problem: Pipework repair for compressed air systems

Solution: Geberit Mapress Stainless Steel (88.9mm and 54mm)

GEBERIT MAPRESS STAINLESS STEEL PERFORMS FOR GREENCORE GROUP

GEBERIT HAVE DELIVERED STEAM, AIR
AND POTABLE WATER FOR THE FOOD FACTORY IN LONDON

→ PROJECT INFORMATION

Building: Greencore Factory
Location: Park Royal, London
Installer: Miramar Engineering
Project Completion: May 2016

→ GEBERIT KNOW-HOW

Problem: Pipe system to deliver steam, air and potable water for food production

Solution: Geberit Mapress Stainless Steel

→ PROJECT OVERVIEW:

Greencore Group plc is a leading international manufacturer of convenience foods, supplying a wide range of chilled, frozen and ambient foods to some of the most successful retail and food service customers in the UK and US.

Its factory at Park Royal in London is part of Greencore's 'Food to Go' business, manufacturing pre-packed sandwiches for major supermarket and high street chains, petrol forecourts and convenience stores.

In May 2016 a new tray wash machine was installed in a refurbished area of the factory, using Geberit Mapress Stainless Steel to deliver steam, air plus hot and cold water. This is the first of five phases of works which will utilise the pressing solution.

→ WHY GEBERIT?

Gregory Pelling, CEO of Miramar Engineering explained their decision to use Geberit Mapress: "During the design process it became apparent that due to the time and space constraints within this project we were going to need to work beyond the normal threaded systems.

"Our Head of Mechanical, Ben Fisher, selected the Geberit Mapress system as the solution. When we presented our recommendation to the client they were impressed with the product selection and reassured by its guarantee. Since installation we have been asked to tender for additional projects for the same client as they were so delighted with the work."



"Speed of installation was proven during the project undertaking and the presentation of the final product shows the quality of the system. The client's expectations have been exceeded and the end result is being presented within the group as an example of what is achievable from a good mechanical install."

Ben Fisher, Head of Mechanical & Project Manager.

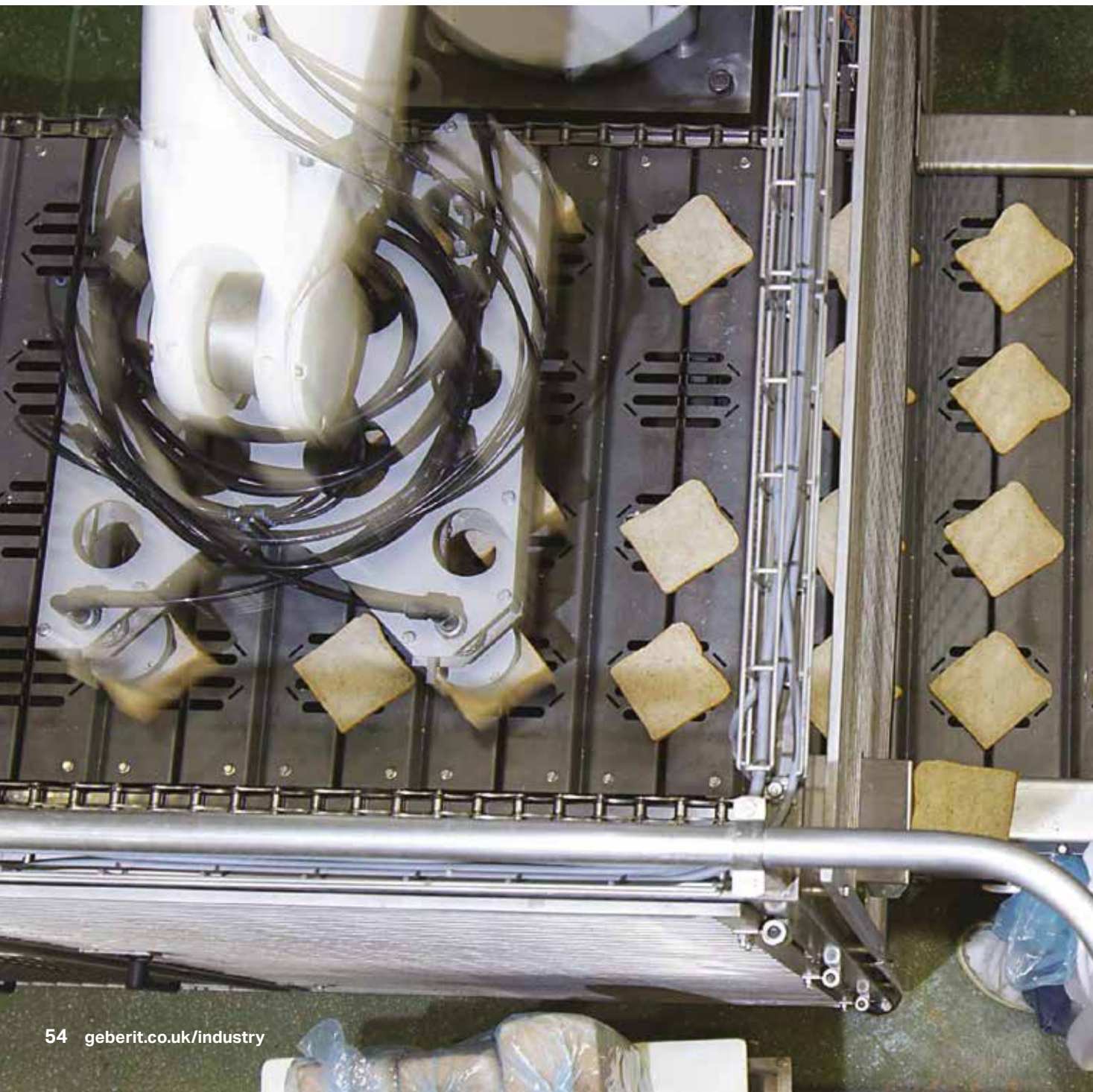

NATIONAL GRID

CHOOSE GEBERIT FOR THE PIER OF THE YEAR

GEBERIT MAPRESS STAINLESS STEEL FOR GAS IS SELECTED FOR LARGE PROJECT FOR THE CLEETHORPES PIER GAS UPGRADE



→ PROJECT INFORMATION

Building: Cleethorpes Pier

Location: Cleethorpes

Client: National Grid/Cadent

Project Completion: April 2016

→ GEBERIT KNOW-HOW

Problem: Gas piping upgrade required for pier

Solution: Geberit Mapress Stainless Steel Gas

→ PROJECT OVERVIEW:

Cleethorpes Pier, named 'Pier of the Year' in 2016, is an iconic Victorian landmark, first opening in 1873. In 2015, the pier was completely refurbished, retaining its traditional beauty with the addition of the latest mod cons and styling, including floor to ceiling windows on one side of the building to capitalise on the dramatic views.

As part of the refurbishment, gas works needed upgrading, switching from expensive bottled LPG to mains gas. Geberit Mapress 88.9mm Stainless Steel gas pipe was installed at high level under the pier structure, joining a meter adjacent to the promenade which now supplies gas to the new kitchen and '1873' restaurant, located at the end of the pier. Specified and installed by the National Grid, this project was the first time the energy provider had used Mapress on a large scale.

→ WHY GEBERIT?

The National Grid usually uses traditional welded steel and screwed piped fittings, but chose Geberit Mapress instead for its corrosion resistant properties and the fact no hot works were required; a key consideration for engineers working in difficult, cramped conditions, often deluged by waves and adverse weather conditions.

Following training from Geberit and some successful trials on smaller installations, the National Grid decided Mapress was the right product for the Cleethorpes Pier gas upgrade. What made it particularly suitable is stainless steel's corrosion resistant properties, essential for gas pipework routed under the pier. From a safety perspective, Geberit Mapress' no hot works credentials were also a big bonus, ideal for engineers working in such an inhospitable environment.

The pier is also a historic structure that cannot be put at risk from fire. One of the biggest benefits of Geberit Mapress was the reduction in time on site, which obviously equated to a financial savings versus the traditional welded and screwed steel process. In addition to this, the lightweight manner of the material made it easier for our installers to lift the pipework into place.

"Cleethorpes Pier's upgrade to mains gas has gone extremely well, with Geberit Mapress proving itself to be a viable solution for the National Grid on future projects."

James Whitmore, Supervisor I&C for the National Grid.



APPROVALS AND MEMBERSHIPS

QUALITY, SAFETY AND RELIABILITY ASSURED

TECHNICAL BUILDING SYSTEM



SHIPBUILDING



INDUSTRY



FOR FURTHER INFORMATION, VISIT

GEBERIT.CO.UK/INDUSTRY

Geberit Sales Ltd

Geberit House
Edgehill Drive
Warwick
CV34 6NH

T 01926 516800

E enquiries@geberit.co.uk

Literature: 0800 007 5133

www.geberit.co.uk/industry